

# IZT S2000

Signal Simulator

Sirius

XM

DVB-T/H

HD Radio



Innovationszentrum Telekommunikations-  
technik GmbH



# IZT S2000

<b>Performance Specifications</b> .....	3
<b>Hardware</b> .....	4
Real-time signal generation .....	4
Chassis.....	4
Modulator Concept.....	4
Arbitrary Waveform Generator and Impairment Simulation.....	4
External Filters.....	4
<b>Software options and supported standards</b> .....	5
Programming Option.....	5
Acceptance Test.....	5
Sirius.....	5
XM.....	7
DVB-T/H.....	9
HD Radio.....	17
<b>Ordering Information</b> .....	16



## Performance Specifications

**The IZT S2000 is a signal source specifically designed for the testing requirements of today's multimedia broadcast systems.**

Manufacturers and developers of multimedia receivers have different requirements for signal generation and test scenarios. Manufacturers are in need of a high quality signal source to perform quick and repeatable tests on each unit produced. Developers require far more complex features with respect to signal generation and impairment simulation. The IZT S2000 is a versatile high-performance signal source designed to satisfy both configuration requirements.

### Key benefits:

- Real-time signal generation
- Powerful impairment simulation
- Simultaneous generation of two different standards
- Up to four RF outputs
- Full remote control capabilities
- Efficient automated type acceptance testing with a single piece of equipment
- Powerful Arbitrary Waveform Generator

### Supported standards:

- Sirius Satellite Radio
- XM Satellite Radio
- DVB-T/H
- HD Radio

Signals for other standards can be generated using the built-in Arbitrary Waveform Generator.

Real-time Modulation	QPSK, QAM16, QAM64, OFDM, AM, FM
Real-time signal generation for	Sirius, XM, DVB-T/H, HD Radio
Arbitray Waveform Generator	4 GB / 16 bit
Impairments	AWGN, Impairment Simulation, Channel Simulation, Interference Signals, Power level profiles, Nonlinearity and Output Filter Simulation, IQ-Imbalance, Antenna Diversity
Frequency range	9 kHz to 3 GHz
Frequency resolution	0.1 Hz
Level range wideband	-110 to +20 dBm peak, stepsize 0.1 dB
Level range narrowband	-130 to +20 dBm peak, stepsize 0.1 dB
Level uncertainty	± 0.5 dB absolute
SSB Phase Noise	< -115 dBc/Hz (@ 3 GHz, 10 kHz offset)

## Hardware

### Real-time signal generation

The combination of powerful digital signal processing with high-quality RF technology allows for real-time signal generation with the IZT S2000. This overcomes the limitation of many competing products, which can only replay a short waveform sample and make interactive variation of the signal parameters difficult or even impossible.

The signal processing power of the IZT S2000 allows the user to emulate real-world continuous signals and realistic impairments.

These real-time signal generation capabilities differentiate the IZT S2000 from most other test signal sources.

Bitstream multiplexing, modulation and all impairment simulations are calculated in real-time. This has a number of advantages over the conventional approach based on short waveform samples stored in Arbitrary Waveform Generators.

- With a storage capacity of 160 GB, hours of real and continuous content can be played out to support the development and testing of receiver and application software.
- The user can control all parameters of the output signal directly in the GUI or remotely without time-consuming offline data generation.

Dimensions (mm)

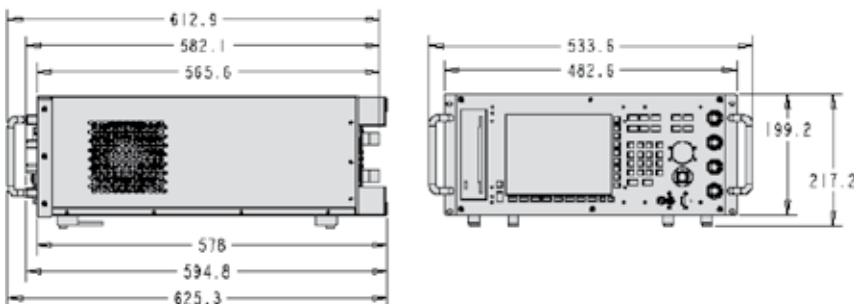

### Chassis

The chassis of the IZT S2000 features a front-panel keyboard and a high resolution display. It can be configured with one or two modulator cards. In addition to the standard remote control interface (LAN, RS232), the chassis can be equipped with a GPIB interface.

### Modulator Concept

The signal generator IZT S2000 excels by its modular concept. It is available with one or two modulator cards each supporting up to two RF outputs. Each software-controlled modulator card can generate the signals of one standard, for example Sirius Satellite Radio, XM Radio, DVB-T/H or HD Radio. A single standard configured IZT S2000 can also be upgraded with additive software to support multiple standards.

It can be configured to support the following output frequency ranges:

- 30 up to 3000 MHz
- 9 kHz up to 3000 MHz
- Narrow-band for XM or Sirius

For DUT's with antenna diversity or special automated test setups, the modulator can be configured with dual RF outputs.

### Arbitrary Waveform Generator and Impairment Simulation

Every modulator card can be equipped with a 4 GB deep Arbitrary Waveform Generator for simulation of interference or replay of wanted signals.

Its content can be added to the modulator signal at adjustable power and with high SNR.

### External Filters

For some test setups, for example Sirius and XM acceptance testing, special accessories are required. These are available as options.

## Software options and supported standards

### Programming Option

The programming option of the IZT S2000 comprises a LabView driver and scenarios. The LabView driver allows you to remotely control the instrument with LabView which is commonly used to create complex test setups with other instruments like power meters and spectrum analyzers. The scenarios can be used to step through a sequence of saved setups of the instrument allowing an unfamiliar user to use the device without the knowledge on how to configure the system.

### Acceptance Test

The IZT S2000 is ideally suited for a fully automated type acceptance test of Sirius or XM receivers without any additional test equipment. The remote control software configures and executes all measurements.

IZT provides the necessary test scenarios and software setups for an automated XM TA2 test.

The IZT S2000's ability to stream actual content further allows its use for XM TA1 testing. For more information please contact IZT.

### Sirius

The IZT S2000 generates the two satellite QPSK signals and the terrestrial COFDM signal used in the Sirius Satellite Radio system. The signals are generated online from stored bitstreams with actual content. The storage capacity is sufficient for hours of music, video and data.

As an option, the IZT S2000 can also generate the Sirius overlay waveform.

The data files required for simulation are incorporated in the product. Either unit can accommodate additional files as desired. The IZT S2000 performs the modulation in real-time. The bitstream data is stored on a 160 GB harddisk, allowing to store more than ten hours of bitstreams.

### Impairment Simulation

In order to accurately simulate the actual RF environment a Sirius receiver operates in, the IZT S2000 provides a number of impairment simulations. These are performed in real-time and can be interactively set by the user.

### AWGN

The IZT S2000 can add white Gaussian noise to the signal with adjustable bandwidth, center frequency and power spectral density. The C/N can be locked to any one of the carriers. (figure 2)

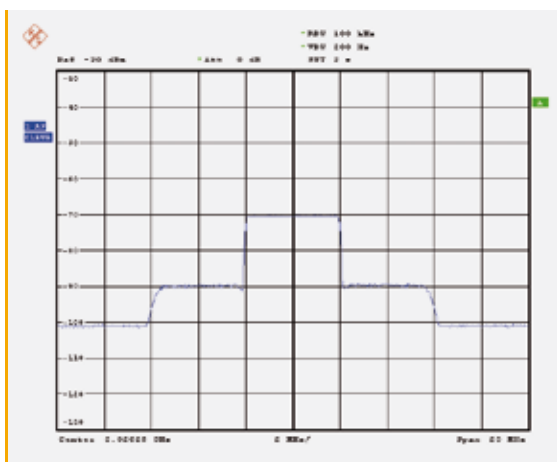

figure 1: Sirius signal: satellite 1, terrestrial and satellite 2

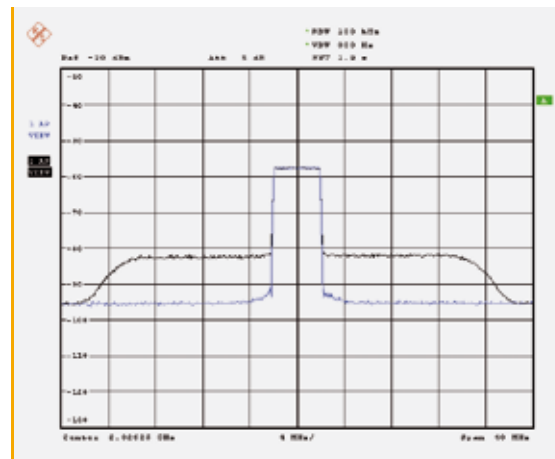
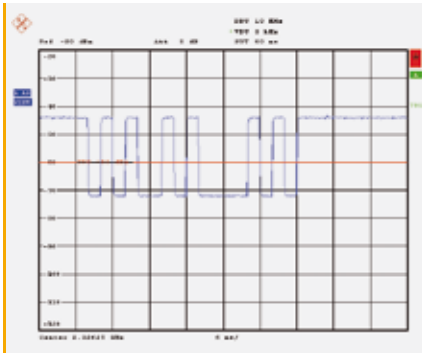
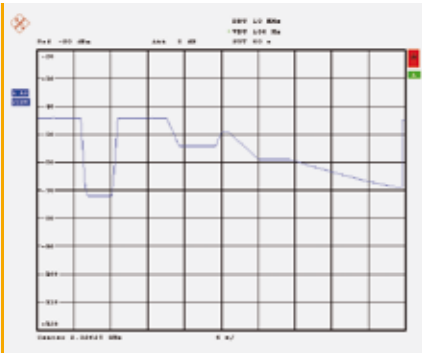

figure 2: Sirius terrestrial signal without (blue) and with AWGN (black)



**figure 3:** Power level profiles generating short burst sequences



**figure 4:** Power level profiles to simulate large scale fading

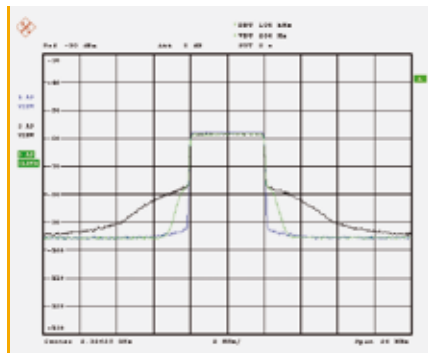

**figure 5:** Sirius terrestrial signal undistorted (blue), simulated nonlinearity unfiltered (black) and filtered (green)

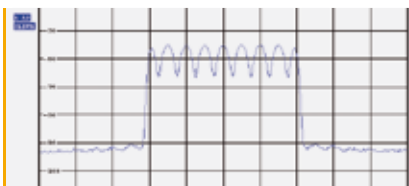

**figure 6:** Sirius terrestrial signal with two-path fading model

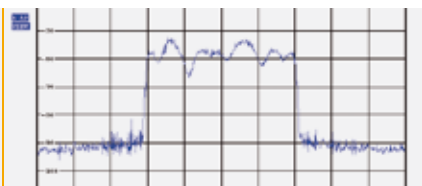

**figure 7:** Sirius terrestrial signal with rayleigh fading

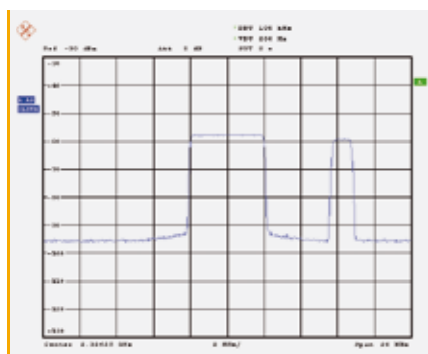

**figure 8:** Sirius terrestrial signal with out-of-band interferer

## Profiles

Carrier power, relative delay between the three signals, center frequency and carrier-to-noise can be varied through user-defined profiles to simulate the moving satellites and large-scale fading. The profiles have a timing resolution of two milliseconds and can be synchronized to the waveform content for repeatable test scenarios.

## Nonlinearity and output filter simulation

For real-world simulation of the signals, the nonlinear behaviour of the power amplifier in the satellites and terrestrial repeaters have to be modelled. The IZT S2000 allows accurate nonlinearity simulation which is independently settable for each carrier and monitoring of the signal parameters. The nonlinearity simulation is combined with a digital representation of the transmitter output filter.

## Channel Simulator

The IZT S2000 contains independent channel simulators for all three signals. Two-path models are used for the satellites QPSK signals and an eight path model for the terrestrial COFDM signal.

## Interference Signals

For testing Sirius receivers, the IZT S2000 can generate various out-of-band interferers with an exceptional dynamic range and signal quality. For XM interference simulation, an accurate spectral representation of the XM terrestrial signals can be generated. Other interference sources, like WCS or cellular phone signals can be stored in the IZT S2000's built-in Arbitrary Waveform Generator with adjustable output power and center frequency.

## XM

For the XM system, the IZT S2000 simulates both ensembles A and B with all carriers simultaneously and exactly synchronized. Each carrier can be adjusted in frequency, delay and power level.

The IZT S2000 combines high signal quality with long, real and continuous content and has been approved for both "Type Acceptance 1"-testing and "Type Acceptance 2"-testing per XM Radio's specifications.

The data files required for simulation are incorporated in the product. Either unit can accommodate additional files as desired. The IZT S2000 performs the modulation in real-time. The bitstream data is stored on a 160 GB harddisk, allowing to store more than ten hours of bitstreams.

### Impairment Simulation

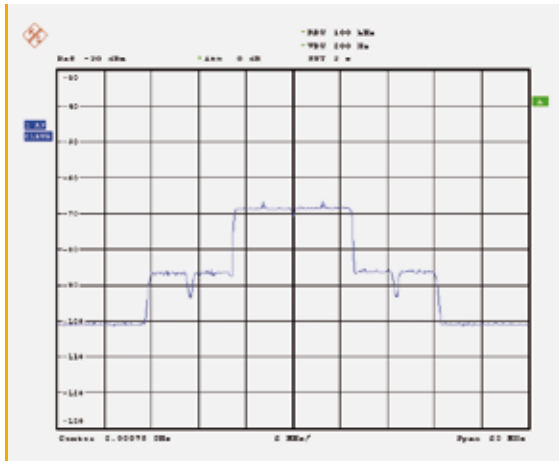

figure 9: XM Signal: satellite 1, terrestrial and satellite 2 for ensemble A and B

In order to accurately simulate the actual RF environment a XM receiver operates in, the IZT S2000 provides a number of impairment simulations. These are performed in real-time and can be interactively set by the user. (figure 9)

### AWGN

The IZT S2000 can add white Gaussian noise to the signal with adjustable bandwidth, center frequency and power spectral density. The C/N can be locked to any one of the carriers. (figure 10)

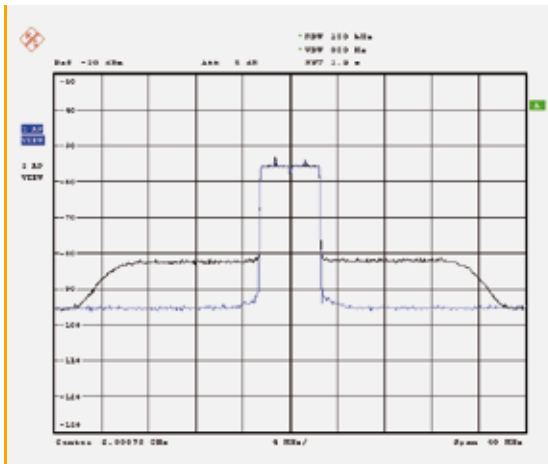

figure 10: XM terrestrial signal without (blue) and with AWGN (black)

### Profiles

Carrier power, relative delay between the three signals, center frequency and carrier-to-noise can be varied through user-defined profiles to simulate the moving satellites and large-scale fading. The profiles have a timing resolution of two milliseconds and can be synchronized to the waveform content for repeatable test scenarios.

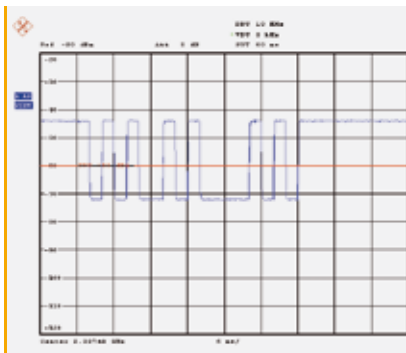

figure 11: Power level profiles generating short burst sequences

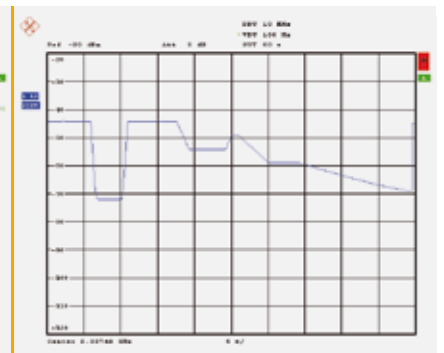

figure 12: Power level profiles to simulate large scale fading

### Nonlinearity and output filter simulation

For real-world simulation of the signals, the non-linear behaviour of the power amplifier in the satellites and terrestrial repeaters have to be modelled. The IZT S2000 allows accurate nonlinearity simulation which is independently settable for each carrier and monitoring of the signal parameters. The nonlinearity simulation is combined with a digital representation of the transmitter output filter.

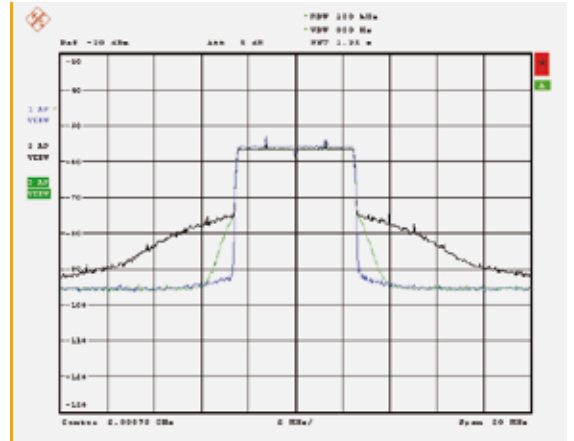

figure 13: XM terrestrial signal undistorted (blue), simulated nonlinearity unfiltered (black) and filtered (green)

### Channel Simulator

The IZT S2000 contains independent channel simulators for all six signals. Two-path models are used for the satellites signals and a eight path model for the terrestrial MCM signal. The eight path model is followed by a four path model to simulate a single frequency network.

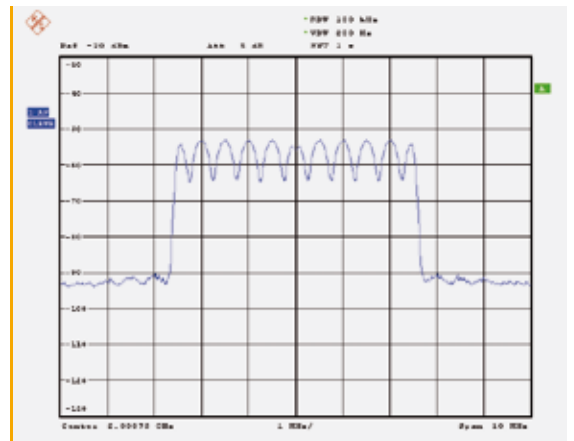

figure 14: XM terrestrial signal with two-path fading model

### Interference Signals

For testing XM receivers, the IZT S2000 can generate various out-of-band interferers with an exceptional dynamic range and signal quality. For Sirius interference simulation, an accurate spectral representation of the Sirius terrestrial signal can be generated. Other interference sources, like WCS or cellular phone signals can be stored in the IZT S2000's built-in Arbitrary Waveform Generator with adjustable output power and center frequency.

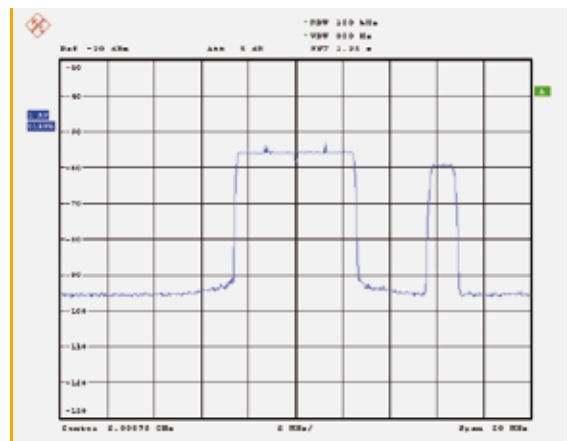

figure 15: XM terrestrial signal with out-of-band interferer



## DVB-T/H

The DVB-T/H option of the IZT S2000 includes multiplexing capabilities, COFDM modulation and the RF upconversion. The input data streams for DVB-T are stored in Transport Stream data files on the internal harddisk. The input data for DVB-H can be stored on the internal harddisk as well and can also be provided via Ethernet in real-time from an external source. The IZT S2000 supports all specified levels of QAM modulation and inner code rates. Two-level hierarchical channel coding and modulation, including uniform and multi-resolution constellations are possible. Two independent MPEG Transport Streams, referred to as the high priority and the low priority stream, are multiplexed from selectable sources and adapted to the appropriate bitrate. The high and the low priority stream are processed separately in the modulator.

### DVB-T/H Waveform

The signals are generated online from stored TS-Files with actual content. The storage capacity is sufficient for hours of music, video and data.

### DVB-T/H Waveform

Waveform	COFDM with QPSK or 4QAM, 16QAM, 64QAM
Transmission Mode	2K, 4K or 8K
Guard Interval	1/4, 1/8, 1/16, 1/32
Coderate	1/2, 2/3, 3/4, 5/6, 7/8
Bandwidth (MHz)	8, 7, 6, 5
Frequency	30 up to 3000 MHz with steps of 1Hz

### Test-video and Test-audio Library

The IZT S2000 DVB-T/H will be delivered with a large variety of test-videos and test-audios and can be easily extended to address further requirements.

### Test Signal Generator

Null packet, PRBS23 and CW generator are included in the IZT S2000. They are used for BER measurements, testing the “out-of-service”-function of receivers. Receivers can also be sent a known, fixed and repeating sequence of PRBS and/or Null packets.

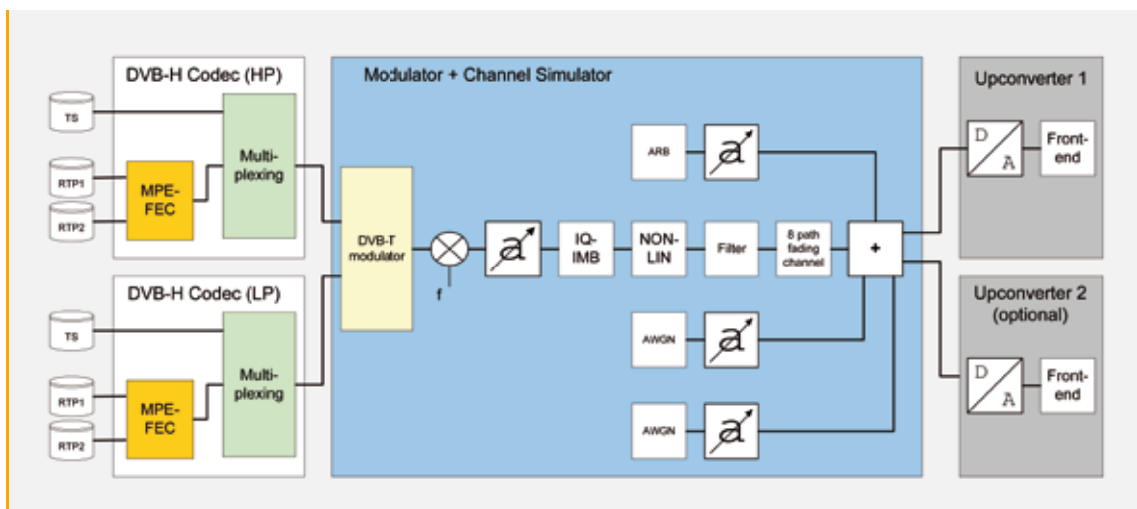

figure 16: Block diagram of DVB-T/H signal generator

### DVB-T/H MUX/Codec

DVB-H is IP based. The DVB-H Codec uses Multi Protocol Encapsulation (MPE) and time slicing to encapsulate the IP packets into a MPEG-2 transport stream. Additional forward error correction

(MPE-FEC) may be added to the stream. A second MPEG-TS Stream (DVB-T) can be multiplexed together with the DVB-H transport stream and transmitted as a combined transport stream.

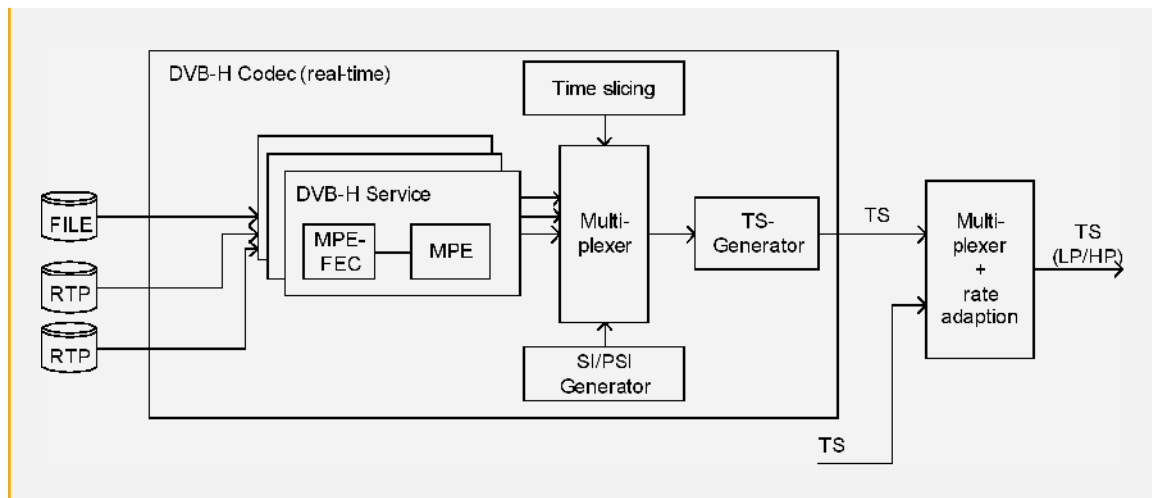

figure 17: DVB-H real-time Codec

Features of the DVB-H Codec	
Input data	RTP / UDP via LAN and H.264 from file in either constant or variable bitrate.
Services	Up to 4 DVB-H services can be processed in parallel and an arbitrary MPEG-TS transport stream can be simultaneously multiplexed to the data stream according to ETSI EN 302 304.
Service parameter editing	Each service can be configured separately in multiple transmission parameters like default bitrate, name, priority, PMT PID, program number, PID.
MPE	Encapsulation of IP-Streams for DVB-H or data content.
MPE-FEC	Code rates of forward error correction can be easily configured: 1/2, 2/3, 3/4, 4/5, 5/6, 6/7 and 7/8 or in detailed settings with rows and columns.
Geographical cell identifier	Configurable longitude and longitude extent, latitude and latitude extent identifier for tests of location based content restriction.
Time slicing	Configurable time slicing cycle for high priority and low priority separately, and constant bandwidth per service.

Multiplexing Output	PSI / SI table scheduling and multiplexing into the data stream. Selectable output speed for multiplexed transport stream. Deviations in bitrate can be used to analyze the effect on a receiver.
PSI / SI table generation	PAT, PMT, NIT, SDT, INT, TDT according to ETSI EN 300 468.
UPD parameter editing	IP-number and port of source (sender) and destination (receiver) can be changed separately for each DVB-H service with a configurable UDP port for each service.
RTP parameter editing	Configurable RTP sequence number checking and RTP streams synchronizeable to playout timestamps.
Transport Stream Generator	Output of DVB-H Codec can be either transmitted to the modulator and RF section or saved to harddisk for later playback. Writing to harddisk is only limited by harddisk capacity.

### Impairment Simulation



figure 18: Impairment page of the graphical user interface

## AWGN

Additive white Gaussian noise is included in the standard configuration of the IZT S2000. The noise can be configured as noise density or locked to one carrier as C/N or C/No.

Two completely separate and uncorrelated AWGN noise sources are available to add noise independently to outputs RF1 and RF2 (optional). The bandwidth, offset frequency, and noise density can also be changed separately for each output.

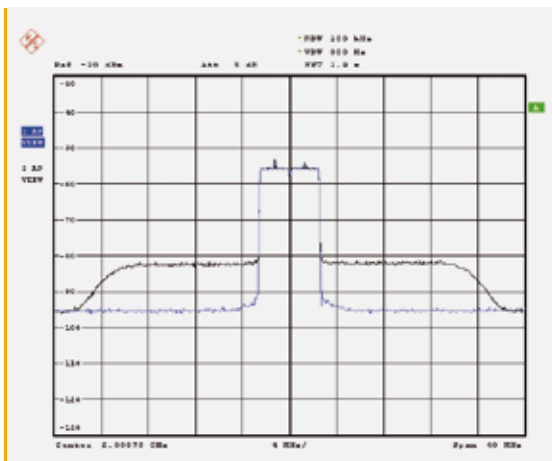

figure 19: DVB signal with AWGN (noise density of -130.0dBm/Hz and 25MHz bandwidth)

## Profiles

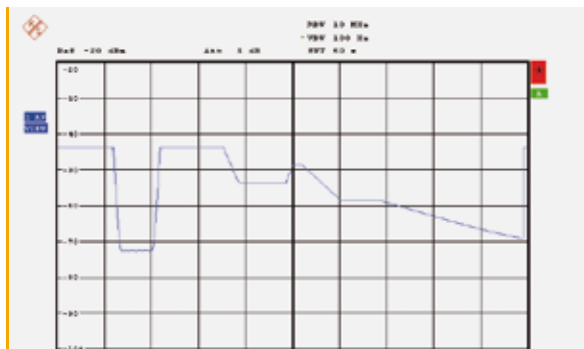

figure 20: Power level profiles to simulate large scale fading

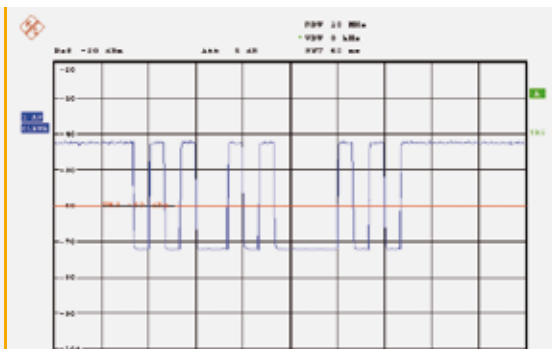

figure 21: Power level profiles generating short burst sequences

## Nonlinearity and output filter simulation

The IZT S2000 supports nonlinearities to simulate AM/AM and AM/PM conversion caused by the power amplifier in the transmitter. The output back-off is measured continuously and can be used for maintaining a user-defined operating point. The spectral re-growth created by the non-linearity would normally cover signals in adjacent channels unless suppressed by the transmitter output filter. Therefore, the IZT S2000 provides an output filter simulation with the characteristics of the real output filter.

In the DVB-T/H option, the user can change between critical and non-critical filter characteristics where the center frequency of the RF output applies different filter characteristics for the output filter simulation.

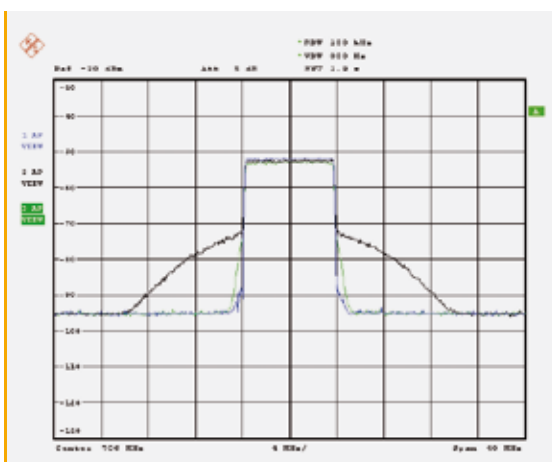

figure 22: Blue: original 8MHz DVB signal, Black: Non-Linearity simulation activated, Green: internal DVB non-critical filter applied

## Fading Channel Simulator

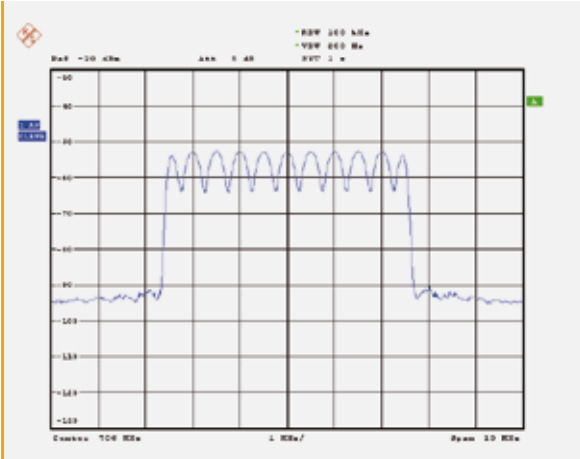

figure 23: Channel simulator with 2 paths, 2µs delayed

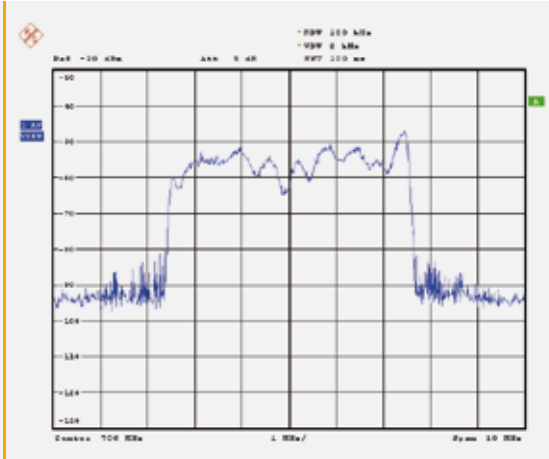

figure 24: Channel simulator with 3 paths and Rayleigh-Fading

The IZT S2000 contains an eight path channel simulator to simulate the terrestrial COFDM signal.

## IQ-Imbalance

The IZT S2000 can simulate DC offset and quadrature errors. The IZT S2000 allows deviations of +/-45 of phase imbalance from the nominal 90 degrees.

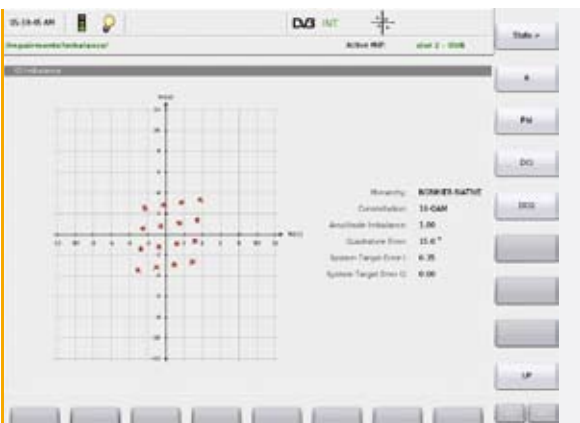

figure 25: Gain imbalance: The IZT S2000 allows up to 50% amplitude imbalance

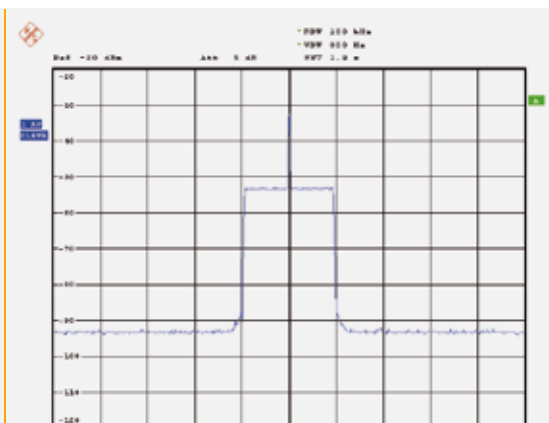

figure 26: IQ imbalance with 15° phase error and system target error I of 0.35

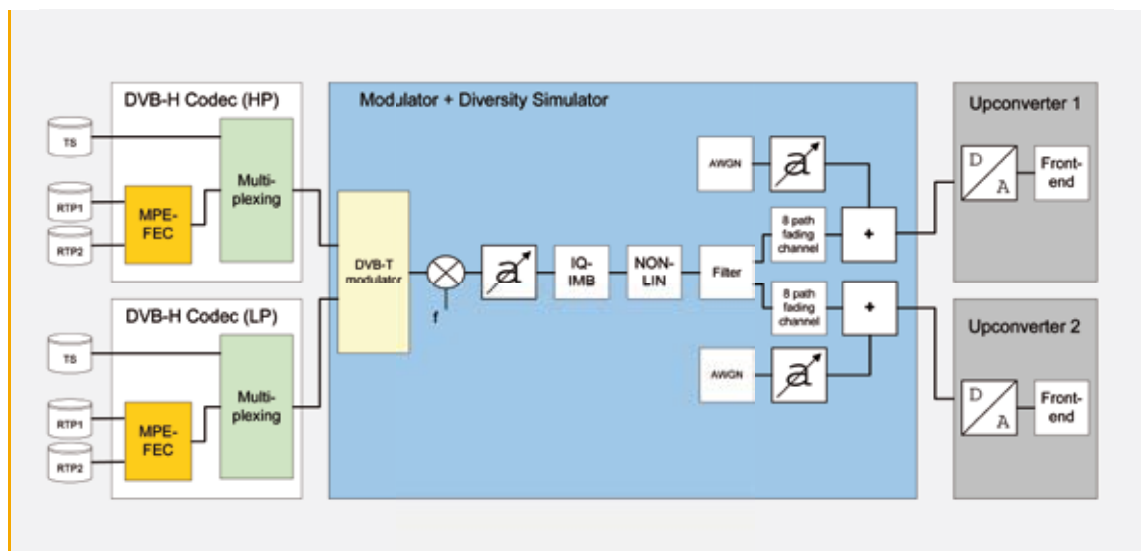

figure 27: Block diagram of DVB-T/H diversity simulation

### Antenna Diversity

DVB-T is for stationary or portable reception of TV/Radio services. If antenna diversity is used, DVB-T can also be used for mobile reception. If diversity is used in DVB-H services, the reception of these services is much improved.

The IZT S2000 can be used to generate two independent channels to simulate diversity reception. Two separate fading simulators are used to generate uncorrelated fading simulating over-the-air reception.

Two noise generators can be used to superimpose noise independently on both channels. Both RF outputs can be used to provide diversity receivers with appropriate signals. Setup of the antenna diversity configuration is very easy.

### Arbitrary Waveform Generator

The Arbitrary Waveform Generator can be used to apply interfering signals as defined in the MBRAI specification. Interference signals can be analog like PAL / SECAM or digital like DVB-T/H.

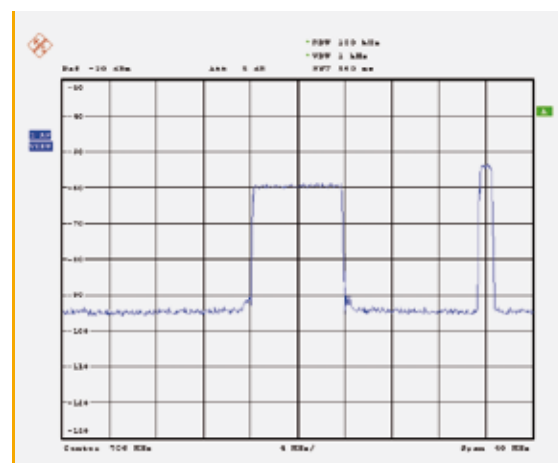

figure 28: DVB 8MHz signal with 1MHz, 0.2 roll-off QPSK signal from ARB

### Acceptance Tests

The IZT S2000 is ideally suited for fully automated type acceptance testing of DVB-T/H receivers per "DVB Measurement Guidelines for Receivers" and IEC 62002 without costly additional test equipment. The remote control software configures and executes all measurements.

## Software Tools and Programming Option

### Transport Stream Configurator

The Windows tool “Transport Stream Configurator” can be used to add configuration information to the transport stream files, automatically configuring the IZT S2000. This way it is very easy to switch between different transport streams from the library.

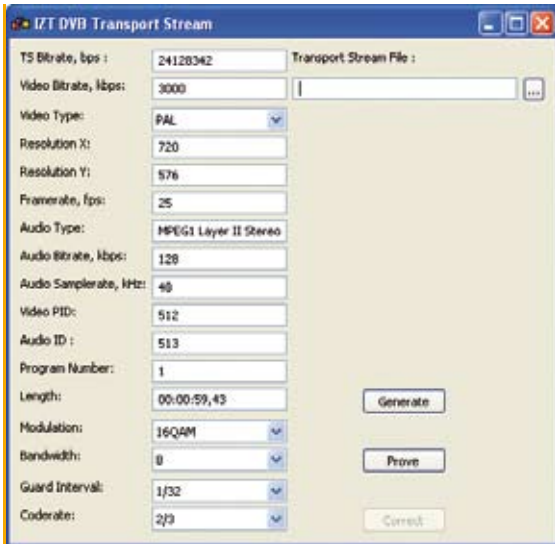

figure 29: The transport stream files can be easily identified in the GUI

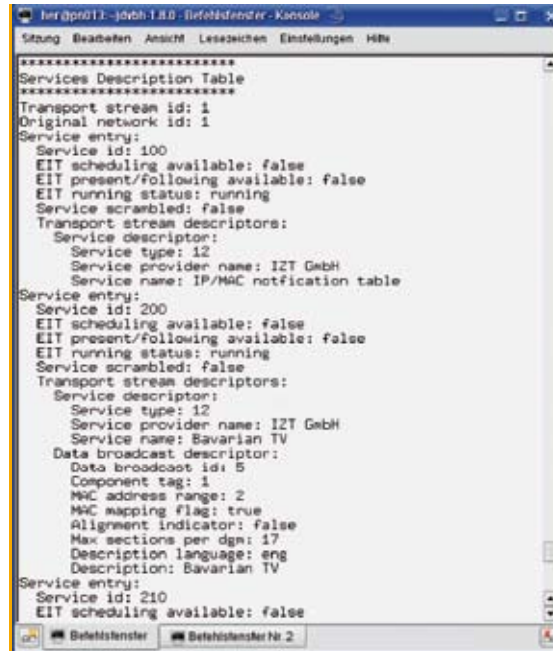

figure 30: Decoded Service Description Table (SDT)

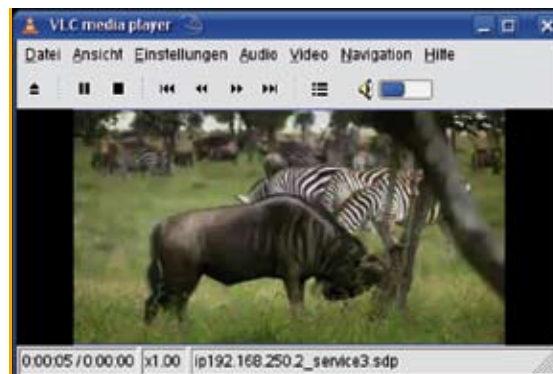

figure 31: All decoded services can be viewed in parallel with a media player like VLC

### Analysis and decoding Software

Analysis of the DVB-H signal can be performed by optional decoder software. It analyzes recorded transport files (TS) or datastreams received by a regular DVB receiver in real time.

The DVB-H Measurement Software is able to analyze:

- PAT (program association table)
- PMT (program map table)
- NIT (network information table)
- SDT (service description table)
- INT (IP/MAC notification table)
- Transport stream dump
- Jitter monitoring
- Time slice monitoring
- Data rate monitoring
- MPE/DVB-H De-capsulation/extraction and video content decoding

## HD Radio

### HD Radio Waveform

The IZT S2000 can generate the test signals for HD Radio for the AM and FM bands. The test vectors are streamed directly from the harddrive.

### Impairments

For interference and compatibility testing, the IZT S2000 generates up to four FM stereo signals with actual content, adjustable power and frequency. Additive white Gaussian Noise and a Fading Channel Simulator are provided as well.

With the optional Arbitrary Waveform Generator, additional interferers with different center frequencies can be simulated.



figure 34: Impairment page to the graphical user interface

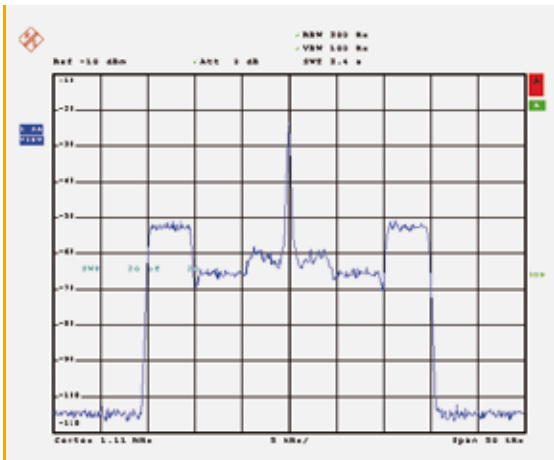

figure 32: AM audio signal with clean channel

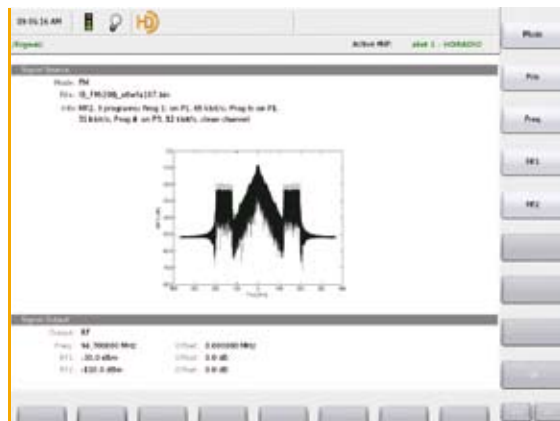

figure 35: Signal page of the graphical user interface

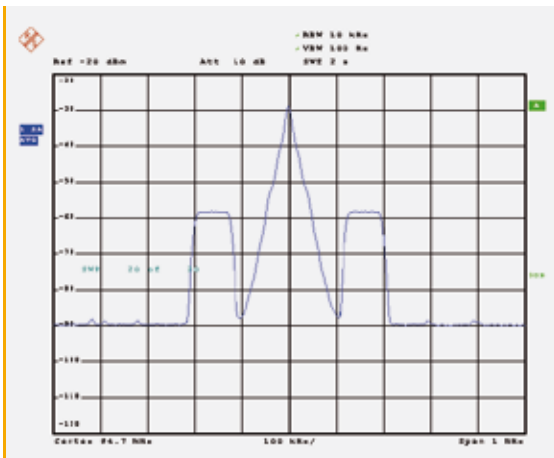

figure 33: FM audio signal with clean channel



## Ordering Information

Ordering Guide		
<b>Hardware</b>	<b>IZT S2000 - CHS</b>	Chassis
	<b>IZT S2000 - MWB(ex)</b>	Modulator Card wideband ex. Sirius/XM Card
	<b>IZT S2000 - MWB</b>	Modulator Card wideband
	<b>IZT S2000 - UWB</b>	Additional wideband upconverter
	<b>IZT S2000 - MNB(ex)</b>	Modulator Card SDARS only ex. Sirius/XM Card
	<b>IZT S2000 - MNB</b>	Modulator Card SDARS only
	<b>IZT S2000 - UNB</b>	Additional upconverter SDARS only
	<b>IZT S2000 - LBX</b>	Low frequency extension
	<b>IZT S2000 - ARB</b>	Arbitrary Waveform Generator
	<b>IZT S2000 - GPB</b>	GPIB
	<b>IZT S2000 - FXM</b>	External filter XM
	<b>IZT S2000 - FSR</b>	External filter Sirius
	<b>Software</b>	<b>IZT S2000 - 001</b>
<b>IZT S2000 - 001a</b>		Sirius Spectral Representation
<b>IZT S2000 - 001b</b>		Upgrade to Sirius waveform
<b>IZT S2000 - 001c</b>		Sirius Overlay
<b>IZT S2000 - 002</b>		XM waveform
<b>IZT S2000 - 002a</b>		XM spectral representation
<b>IZT S2000 - 002b</b>		Upgrade to XM waveform
<b>IZT S2000 - 003</b>		DVB-T/H waveform
<b>IZT S2000 - 003a</b>		DVB-T/H MUX/Codec
<b>IZT S2000 - 004</b>		HD Radio waveform
<b>IZT S2000 - 100</b>		Impairment Simulation
<b>IZT S2000 - 100a</b>		Profiles
<b>IZT S2000 - 100b</b>		High Power Option
<b>IZT S2000 - 100c</b>		Output filter simulation and Nonlinearity
<b>IZT S2000 - 100d</b>		Channel Simulator
<b>IZT S2000 - 200</b>		Programming Option



REV.3.0 04/2008 DEKRA@0001.XDE

## About IZT

The Innovationszentrum fuer Telekommunikationstechnik GmbH IZT specializes in the most advanced digital signal processing and field programmable gate array (FPGA) designs in combination with high frequency and microwave technology.

The product portfolio includes equipment for signal generation, receivers for signal monitoring and recording, transmitters for digital broadcast, digital radio systems, and channel simulators. IZT offers powerful platforms and customized solutions for high signal bandwidth and real-time signal processing applications. The product and project business is managed from the principal office located in Erlangen/Germany.

IZT distributes its products worldwide in cooperation with its international strategic partners IZT Pacific, IZT Technologies and MaXentric Technologies. The customers are civil companies, governmental agencies and armed forces. The IZT quality management system is ISO 9001:2000 certified. The company website can be found under <http://www.izt-labs.de/>.



## Innovationszentrum für Telekommunikationstechnik GmbH IZT

General Manager:  
Rainer Perthold

Am Weichselgarten 5  
D-91058 Erlangen, Germany

Phone: +49 (0)9131 4800-100

Fax: +49 (0)9131 4800-190

[www.izt-labs.de](http://www.izt-labs.de)  
[sales@izt-labs.de](mailto:sales@izt-labs.de)